

Off-Highway Systems

Complete Drivetrain Solutions



SPICER®
Off-Highway Systems



Construction



Agriculture



Mining



Forestry



Material
Handling



Outdoor Power
Equipment



Leisure
Vehicles



Utility Vehicles



M. Knöpfli AG
Wiesackerstr. 128
8105 Regensdorf
Tel: ++41 44 840 62 21
info@m-knoepfli.com



For more than a century, Dana has helped vehicle and equipment manufacturers adapt to an ever-changing world with an unwavering commitment to innovation and quality. Virtually every major vehicle manufacturer in the global automotive, commercial-vehicle, and off-highway markets relies on Dana to provide superior drivetrain products with the respected Spicer® brand name supported by unmatched engineering expertise and customer service. With facilities strategically located around the world and quality-driven manufacturing operations that ensure just-in-time delivery to customers, Dana can apply its global resources to meet your distinct needs.



Collaboration and Integration To succeed in the increasingly competitive market for off-highway vehicles and equipment, manufacturers focus their resources on their core competencies: meeting customer demand, expanding their brands globally, and providing top-rate service.



Dana is committed to serving as a single resource OEMs can rely on for managing the complexities of drivetrain systems integration, while delivering the supply chain and purchasing efficiencies expected of a Tier I supplier. From initial concept to final delivery and after-sales service, Dana is uniquely qualified to accelerate vehicle development based on the company's extensive experience with a wide spectrum of applications.

Expertly managing the growing complexity of today's off-highway drivetrain systems requires a holistic approach to the development of transmissions, axles, electronic controls, and driveshafts. Dana engineers succeed by coordinating the development of each component's technical specifications to optimize the efficiency of the entire drivetrain and maximize the tractive, productive, control, and ergonomic performance of the vehicle.

Dana technology and expertise are backed by decades of experience in developing drivetrain solutions for the entire spectrum of off-highway manufacturers, including agriculture, construction, forestry, mining, material handling, and outdoor power equipment and leisure/utility vehicles.

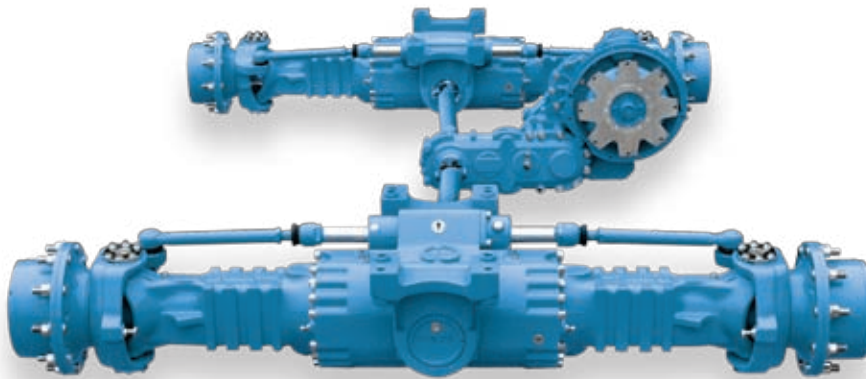

◀
As a Tier I supplier, Dana works closely with customers to design comprehensive drivetrain solutions.





A Full Line of Products Customers turn to Dana for innovation and quality, and every Spicer® drivetrain component is designed, tested, and manufactured to meet customers' exacting standards. From the finest detail on every transmission, axle, electronic control, and driveshaft to the integration of all the components into a complete system, customers can count on Dana for drivetrains that excel over the long haul.

Complete Drivetrain Systems

With engineering teams and manufacturing operations strategically positioned around the world, Dana has deployed its resources to deliver proven systems integration capabilities for OEMs.

Starting with the initial design concept, Dana engineers work in teams to jointly develop all the components used on each drivetrain system in families of modules to ensure they work as an integrated system. This process optimizes performance and improves the cost-effectiveness of the overall system.

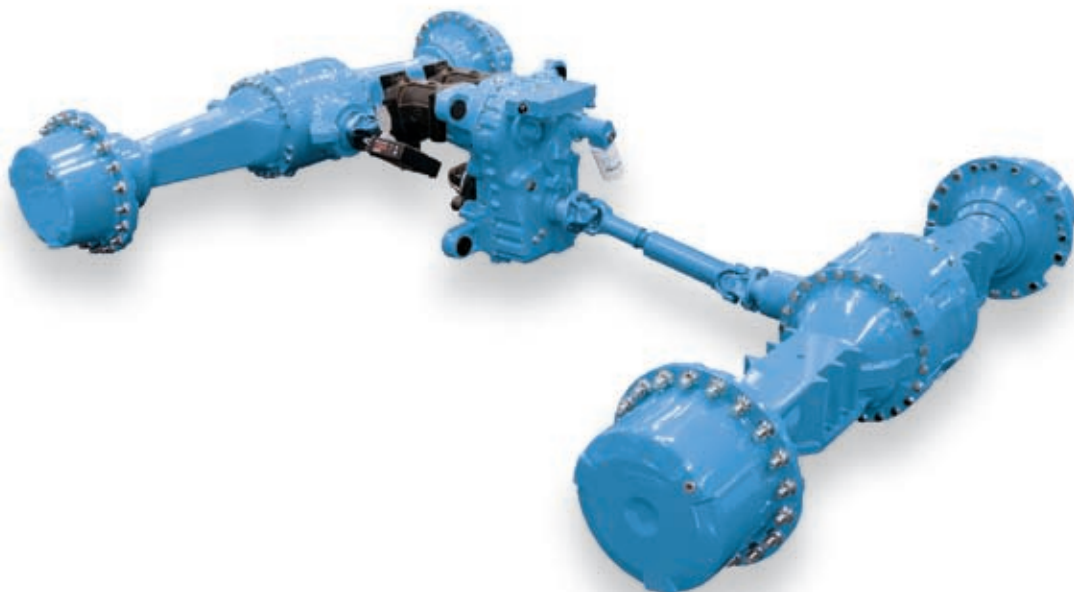

Transmissions

Dana supplies a full range of Spicer transmissions and torque converters capable of handling performance needs ranging from 50 to 1,000 horsepower (37 to 746 kW). Dana offers a transmission solution for any off-highway need, including transfer cases, hydrostatic transmissions, powershift transmissions, and torque converters.



Dana produces customized drivetrains for the unique demands of each vehicle, such as the Spicer® Model 26 drivetrain assembly designed for all-terrain vehicles.

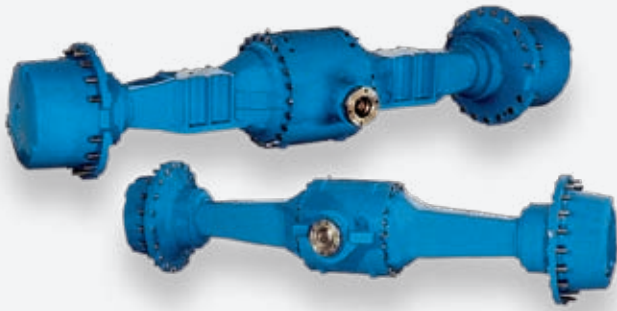

Axles

Dana makes Spicer® axles designed with load ratings from 1,200 to 140,000 pounds (545 to 63,600 kg). As the established, single source for the widest range of off-highway axles, Dana supplies a comprehensive line that includes single-reduction and planetary drive axles in both rigid and steer versions, as well as portal, bogey, non-drive steer axles, and transaxles.

Dana has designed its axle platforms with a wide range of track widths, foundation service brakes, parking brakes, vehicle frame attachments, and biasing differential options.

Spicer single-reduction axles deliver load-carrying capacities from 3,300 to 18,000 pounds (1,500 to 8,180 kg), with multiple brake options. Dana supplies drive-steer, rigid, independent carrier, and non-drive options of these axles.

Spicer planetary steer axles offer various steer angles, ratios, and capacities, while planetary rigid axles also provide many different selections of ratios, wheel mountings, and sizes.

And all Spicer axles are engineered to deliver maximum performance as well as easy, low-cost service and maintenance through features customized to meet the specific needs of each application.

Electronic Controls

The productivity of any machine depends on the operator's ability to smoothly and efficiently command the vehicle. Dana provides operators with the help they need through electronic controls that optimize performance and ease of use while improving durability.

Dana manufactures Spicer electronic controls that enable state-of-the-art transmission features such as electronic modulation, electronic throttle, brake-by-wire, brake-by-clutch, electronic single-pedal drive capability, and electronic inching.

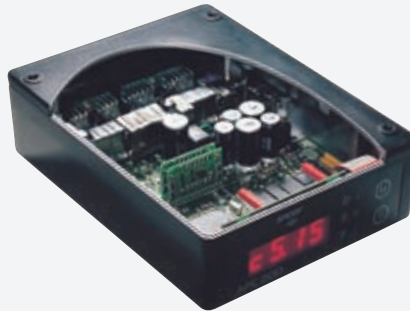

Electronic controls are capable of improving vehicle and operator performance by shifting automatically at predetermined speed and load points, maximizing auxiliary power performance, providing safety inhibits, and supplying monitoring and diagnostic capabilities.

Driveshafts

Dana continuously develops new designs, materials, and processes for Spicer driveshafts that provide more power, greater efficiency, and better overall performance.

More than a century of quality and innovation is reflected in every Spicer product, ranging from 400 Nm driveshafts for leisure/utility vehicles up to 15,000,000 Nm driveshafts used in industrial applications.



The Spicer® Model 970 axle is a prime example of a truly innovative design with reduced complexity and simpler assembly that saves OEMs time and costs in final assembly.

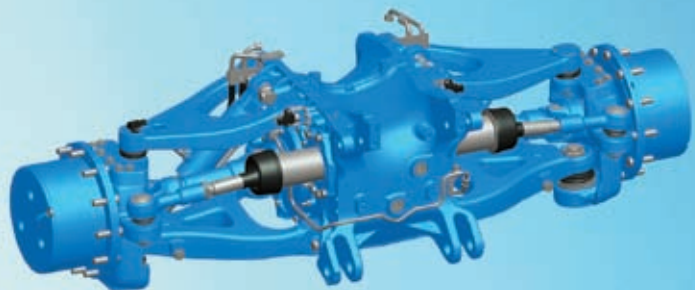



Research and Development Dana has deep roots in innovation, beginning with Clarence Spicer's invention of the encased universal joint in 1904. From that moment forward, Dana has been keenly focused on producing high-quality, technologically advanced products for customers backed by competitive pricing and world-class service.

To achieve these goals, Dana invests heavily in research, development, and sustaining engineering. As a result, Dana improves the reliability, performance, and cost-effectiveness of existing products while designing and developing new products.

Dana has global research and development operations that are integrated to create a collaborative environment that fosters innovation, accelerates product development, maximizes efficiency, and improves communication and information sharing.

By following a robust process for developing new products, Dana engineers can quickly design and model complex structures and systems, identify and resolve potential issues early in the development process, and ultimately deliver durable, highly reliable products and systems.



◀
With resources for research and development deployed around the globe, Dana offers OEMs a short lead time for drawings, materials, and testing.





Throughout the entire research and development process, Dana works closely with customers to produce an integrated drivetrain system designed for the installation, assembly, and maintenance requirements of each vehicle.



OEMs rely on Dana because Spicer® products are precisely engineered, crafted with high-quality materials, and subjected to rigorous tests.





Testing To ensure that Dana products deliver superior performance under the most demanding conditions, Dana puts its off-highway drivetrain components through a challenging battery of tests on individual components, integrated systems, and fully built prototype vehicles.

Dana demonstrates its commitment to testing at state-of-the-art Off-Highway Systems Technology Centers located in Belgium, Italy, and the United States. These facilities have been designed to deliver well-tested, highly reliable products in the shorter, more efficient development cycles demanded by OEMs in the competitive off-highway vehicle market.

Technology Center laboratories feature test rigs, instrumentation, and automation capabilities for both endurance and life testing of components, subassemblies, and complete transmission and axle assemblies. Dana labs are also equipped with sophisticated tools and test benches for research on core technologies, such as hydraulic valves, mechatronics, and wet-friction clutches and brakes.



Beyond the lab, Dana puts prototype vehicles to the ultimate challenge on the test track proving grounds in Arco, Italy, which offers numerous test surfaces and driving conditions for evaluating temperature, velocity, RPM, stress or strain, deflection, load, pressure, and acceleration.

Dana puts its drivetrain systems through a series of tests, including:

- Chassis dynamometer driving simulations over rough terrain
- Structural stress and fatigue tests
- Controller and clutch driving simulations
- Durability dynamometer tests of gears, bearings, and lubrication
- Numerous hydraulics tests, including static loop, dynamic loop, durability, and disconnect tests
- Hydraulic and electric control systems tests
- Engine and clutch smoothness tests, and torque transmission tests
- Fluid sealability tests
- Efficiency and parasitic loss development



The torsional durability test validates original design calculations and exemplifies the constant pursuit of quality at every stage of systems development.

Manufacturing OEMs turn to Dana as a Tier I supplier of complete drivetrain systems integration because Dana has established a culture of continuous improvement throughout all of its manufacturing operations that makes the customer the first priority. This commitment to operational excellence ensures the production of reliable, high-quality drivetrains wherever they are manufactured.



Dana achieves superiority by better aligning company resources and support infrastructure to ensure that manufacturing operations are capable of being best-in-industry performers.

To achieve this goal, everyone at Dana – from team members to senior managers – continuously pursues systematic process improvement by understanding, appreciating, and practicing the fundamentals of the Dana Operating System on a daily basis.

Based on the Toyota Production System, the Dana Operating System focuses on making improvements in every plant and process through a standard set of values, processes, tools, and metrics. These principles guide Dana in the production of high-quality drivetrain systems with no waste or variation and with 100 percent on-time delivery.

Dana values the input of every member of the manufacturing team and supports them with the technology, management, and philosophy that helps them maximize the efficiency of manufacturing processes and deliver consistently high-quality products.

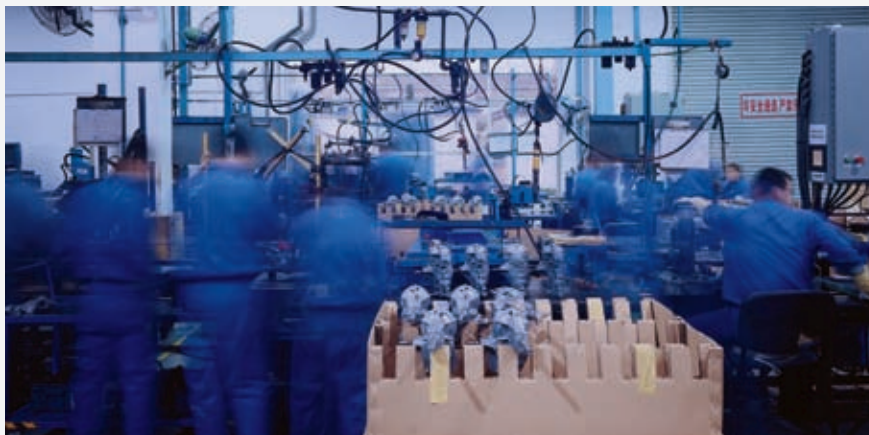

Dana follows lean manufacturing principles to meet its customers' just-in-time assembly schedules.

The Dana Operating System sets a high standard and drives manufacturing operations around the world to produce exceptional drivetrain systems and components for customers, wherever they are located.

By using proven lean manufacturing principles, the Dana Operating System has established a team culture that results in more efficient warehousing and parts replenishment, encourages autonomous maintenance, generates a consistent flow of production, and rapidly identifies and corrects manufacturing anomalies.

Dana monitors the operations at every one of the more than 100 Dana manufacturing and assembly facilities worldwide by reviewing key performance indicators for safety, quality, productivity, overall equipment effectiveness, inventory, and conversion cost.

Dana suppliers must also demonstrate their ability to meet the highest standards for operational efficiency and product quality by:

- Driving continuous improvement in their organization through tools such as Value Analysis/Value Engineering, as well as Excellence in Manufacturing
- Keeping current with best practices through educational development
- Dramatically reducing defective parts per million (PPM) rates toward the Dana corporate goal of 50 or less

- Continuously improving performance in Dana's Supplier Performance Feedback System rating system

By continuously striving toward operational excellence, Dana provides customers with the drivetrain components and systems they need assembled with the high quality they demand and delivered in a timely, efficient way that supports their own just-in-time manufacturing processes.



Dana seeks input for improving efficiency and producing consistently high-quality drivetrain systems from every member of the manufacturing team.





The Dana Operating System employs proven workspace and work flow improvement principles to maximize efficiency.



Industry Expertise With more than a century of experience in every mode of transportation, Dana has supported manufacturers with Spicer® drivetrains for every kind of off-highway vehicle. From vineyard tractors and golf carts to feller bunchers and backhoe loaders, Dana has produced drivetrain components and complete drivetrain systems for all types of off-highway equipment.

Dana supplies manufacturers with a wealth of engineering expertise as well as first-hand experience with the buyers and operators of equipment for the agricultural, construction, forestry, mining, material handling, and outdoor power equipment and leisure/utility vehicle industries.

Dana engineers know how off-highway vehicles are used, where they are used, in what climates and other extreme conditions they are used, what they are designed to do, and what they are asked to do beyond their design. This hands-on knowledge helps Dana develop and build systems that will stand the test of time.



Agricultural An ever-growing world population, coupled with an increasing appetite for biofuels, will continue to boost demand for agricultural machinery in the decades to come. Agricultural customers are looking to increase the yield from their land and improve efficiency in harvesting their crops — all while complying with evolving emissions standards and improving operator safety and comfort.



Agricultural products vary greatly from region to region, and OEMs must supply a wide variety of vehicles to help farmers bring their crops to market. Through advanced technology and streamlined operations, Dana serves as a major supplier of drivetrains specifically designed for the unique demands of agricultural tractors, articulated and non-articulated tractors, vineyard tractors, compact tractors, specialty harvesting equipment, and combines.

Dana proactively addresses the specific requirements of the agricultural market by producing front drive axles and drivetrain products that are rugged enough to work on uneven ground under constantly heavy loading conditions. Spicer® front drive axles for agricultural machinery are engineered with optional wet service brakes to enable high-speed transport.

With a complete portfolio of suspended axles, Dana supplies technology that allows agricultural equipment to work faster and maximize productivity while keeping operators comfortable and alert.



Agricultural



▶
Spicer® drivetrain systems help maximize yield and improve efficiency.



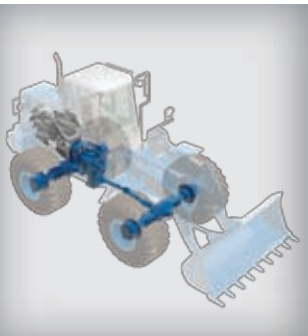

Construction Every construction vehicle performs a different task on the job site, but they all have a few characteristics in common. As demands for productivity increase, they all must perform at high levels of efficiency with little maintenance while working in hostile environments that exert high torques and loads on the equipment.

Dana supports a broad range of construction vehicles from four to 55 tons (3,600 to 50,000 kilograms) with axle and transmission solutions that deliver the required tractive effort. Spicer® high-horsepower pump-drive solutions provide responsive lift-cycle times for buckets, scoops, stabilizers, forks, and other hydraulically driven accessories.

Traction is key for both productivity and safety on the varied, uneven, and unpaved terrain found at construction sites, and Dana offers several torque-biasing differential options, each custom-engineered to suit specific ground traction conditions across vehicle applications.

Drivetrain systems for construction equipment are designed with internal, fade- and maintenance-free, liquid-cooled brakes, lube-for-life driveshafts, and other innovations that minimize equipment downtime and maintenance costs.



And Dana addresses operator fatigue through electronic controls that improve shift quality and reduce acceleration jerk while supplying seamless transitions for the entire range of equipment maneuvers.

OEMs rely on Dana to produce integrated drivetrain systems for a variety of equipment used on construction sites, including wheel loaders, wheeled excavators, telescopic boom handlers, aerial work platforms, compactors and rollers, backhoe loaders, wheeled cranes, pavers, haulers, and ditchers and trenchers.

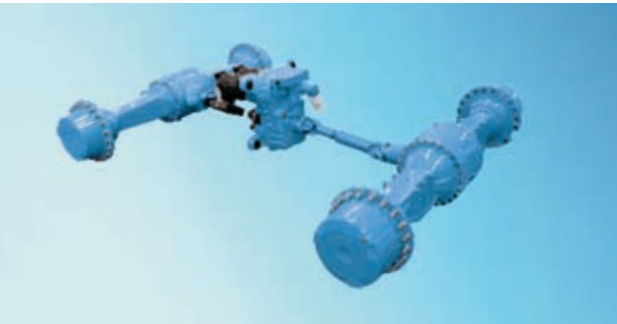

Traction is essential on construction sites, and Dana offers several torque-biasing differential options.



Forestry and Mining Vehicles used in forestry and mining operate in the most severe environments in the world, and yet they are expected to move enormous volumes of materials quickly to waiting trucks or a central staging point. Working continuously in remote, inaccessible locations, this equipment is subjected to abuse from the elements and rough treatment from operators.

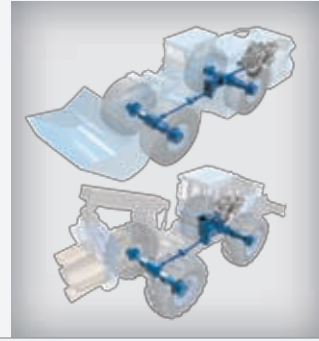

Dana has designed complete drivetrain systems that supply improved positioning, traction, braking, and reliability, as well as many other unique features specifically engineered to maximize the productivity of forestry and mining vehicles.



Dana maximizes flexibility for vehicle designers by offering converter and transmission packages with integral, mid-mount, and remote configurations. Spicer transmissions also feature innovations such as advanced charge pump systems, which provide increased oil flows to maximize performance in high-energy duty cycles as well as cold temperature environments.

mining vehicles are world-renowned for delivering high-integrity, high-reliability performance through spring-applied hydraulic-release (SAHR) actuation.

Dana makes customized drivetrain systems for high-volume forestry vehicles including log skidders, feller bunchers, tree harvesters, and forwarders.

Simple and reliable liquid-cooled braking systems increase stopping power and decrease brake temperatures by distributing the braking effort over a high percentage of the axle surface envelope. In fact, the Posi-Stop™ fail-safe service brakes predominantly used in ramp

Mining vehicles using Dana drivetrains include scoops, shuttles, mine trucks, load-haul-dumps (LHDs), personnel carriers, self-propelled blast-hole drills, and site utility vehicles.

Spicer® axles for forestry and mining equipment offer many differential designs that supply the excellent torque bias performance and required traction on varying ground conditions. For example, the Hydraloc™ torque-biasing differential provides optimum maneuverability and traction on the widely varying ground conditions found in logging environments.



Forestry and Mining



▶
The Spicer® Model 58R397 axle is designed for high-performance, low-maintenance operation on large load-haul-dumps (LHDs) and mining trucks.



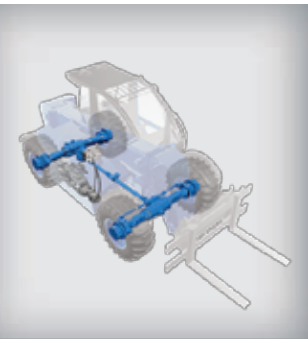

Material Handling Working around the clock and seven days a week to move high volumes of goods, material handling vehicles are the key to profitability in the transportation industry. Speed and load capacity are particularly important, because faster turnaround time — and therefore higher volume — equals a better profit margin, with safety a key requirement as well.

Dana supplies OEMs with drivetrain components for a wide variety of material handling vehicles from two-ton (1,800-kilogram) forklift trucks to 50-ton (45,000-kilogram) reach stackers. These drivetrains are equipped with the power to handle any load, combined with simplified controls to increase handling and safety for operators with a wide range of skill levels.

Spicer® transmissions supply reliable power for accessories used to engage, lift, and transport heavy loads managed by an advanced electronic control system that provides electronic clutch modulation (ECM), electronically controlled inching (ECI), and safety inhibit protection.

Performance and safety are enhanced with an oil-immersed wet brake system, available on even the smallest material handling vehicles. Utilizing a fully enclosed design, these brakes are sealed and protected from water, dirt, and other contaminants encountered in ports, terminals, container yards, heavy industry sites, and distribution centers.

Wet brakes also help keep both equipment and operators working at peak efficiency for extended periods of time by reducing brake wear and noise.

Dana produces drivetrain components and complete systems for manufacturers of forklift trucks, reach stackers, straddle carriers, terminal tractors, railroad terminal tractors, and gantry cranes.



Spicer® drivetrains for material handling vehicles are designed with the power and precise control needed to maximize productivity.



Outdoor Power Equipment and Leisure/Utility Vehicles While smaller than other off-highway vehicles, outdoor power equipment and leisure/utility vehicles are still expected to deliver the same low-maintenance, high-quality performance. These price-sensitive consumer applications highlight the importance of value analysis/value engineering in producing power transmission systems for a tight design envelope.



Dana serves the unique needs of these customers by delivering application-specific customization in any area of the assembly, with flexibility in tire tracks, bracketry, angle of carrier assembly, and left- and right-hand axle shaft and tube lengths.

Manufacturers of a wide range of applications rely on Dana to supply Spicer® drivetrains customized for all-terrain vehicles (ATVs), utility vehicles, light-duty haulers, commercial mowers, golf cars, front- and rear-engine riding mowers, neighborhood electric vehicles (NEVs), small utility vehicles, personal carriers, garden tractors, and walk-behind mowers.



Dana works closely with customers to engineer a comprehensive solution that takes into account the demands each vehicle or piece of equipment will place on the drivetrain. With supply chain, manufacturing, assembly, and logistics optimized for a global market that ebbs and flows with the changing seasons, Dana is uniquely positioned to supply components on a just-in-time delivery schedule.



Outdoor Power Equipment
Leisure/Utility Vehicles



Dana custom-engineers advanced drivetrain systems, such as the Spicer® Model 6800 transaxle for riding mowers, through close collaboration with manufacturers.





Parts and Service Spicer® drivetrains for the off-highway market deliver superior performance day after day because they are precision-engineered, crafted with high-quality materials, and subjected to rigorous tests. When service is needed, only Spicer Service Parts can provide the reliability your off-highway vehicle needs to reduce downtime and cost.



Dana subjects genuine Spicer Service Parts to several processes that ensure consistent quality and exceptional durability, including superior metallurgy, hobbed and shaved gearing, and precision heat-treating and shot peening.

Dana Off-Highway serves the specific needs of its customers by operating two global service parts distribution centers and more than 50 authorized Spicer Service Centers for customers in more than 100 countries.

Technicians are always available with practical knowledge and hands-on experience to support customers in a variety of ways — from performing a field diagnosis to conducting new product training at a customer facility.

Dana also keeps equipment running through parts marketing, custom labeling, global market pricing, direct sales support, and customer-secure ordering systems at www.Spicerparts.com/order.asp.

ASIA-PACIFIC

- Australia
- China
- India
- Indonesia
- South Korea
- Malaysia
- New Zealand
- Philippines
- South Africa
- Singapore
- Thailand

EUROPE/ASIA/AFRICA

- Algeria
- Austria
- Belgium
- Bulgaria
- Czechia
- Denmark
- Deutschland
- Egypt
- Espana
- Estonia
- Finland
- France
- Greece
- Iceland
- Ireland
- Italy
- Kazakhstan

- Latvia
- Lithuania
- Macedonia
- Malta
- Morocco
- Norway
- Polska
- Portugal
- Romania
- Schweiz
- Serbia
- Slovakia
- Sweden
- Syria
- The Netherlands
- Tunisia
- Turkey
- United Kingdom

NORTH AMERICA

- Canada
- Mexico
- USA

SOUTH AMERICA

- Argentina
- Brazil
- Chile
- Peru



Global Footprint Dana Holding Corporation operates facilities strategically located on six continents, serving more than 1,000 vehicle assembly and manufacturing facilities in 30 countries. Only Dana can harness the technology, expertise, and exceptional service needed to meet the unique needs of all customers, wherever they are located.

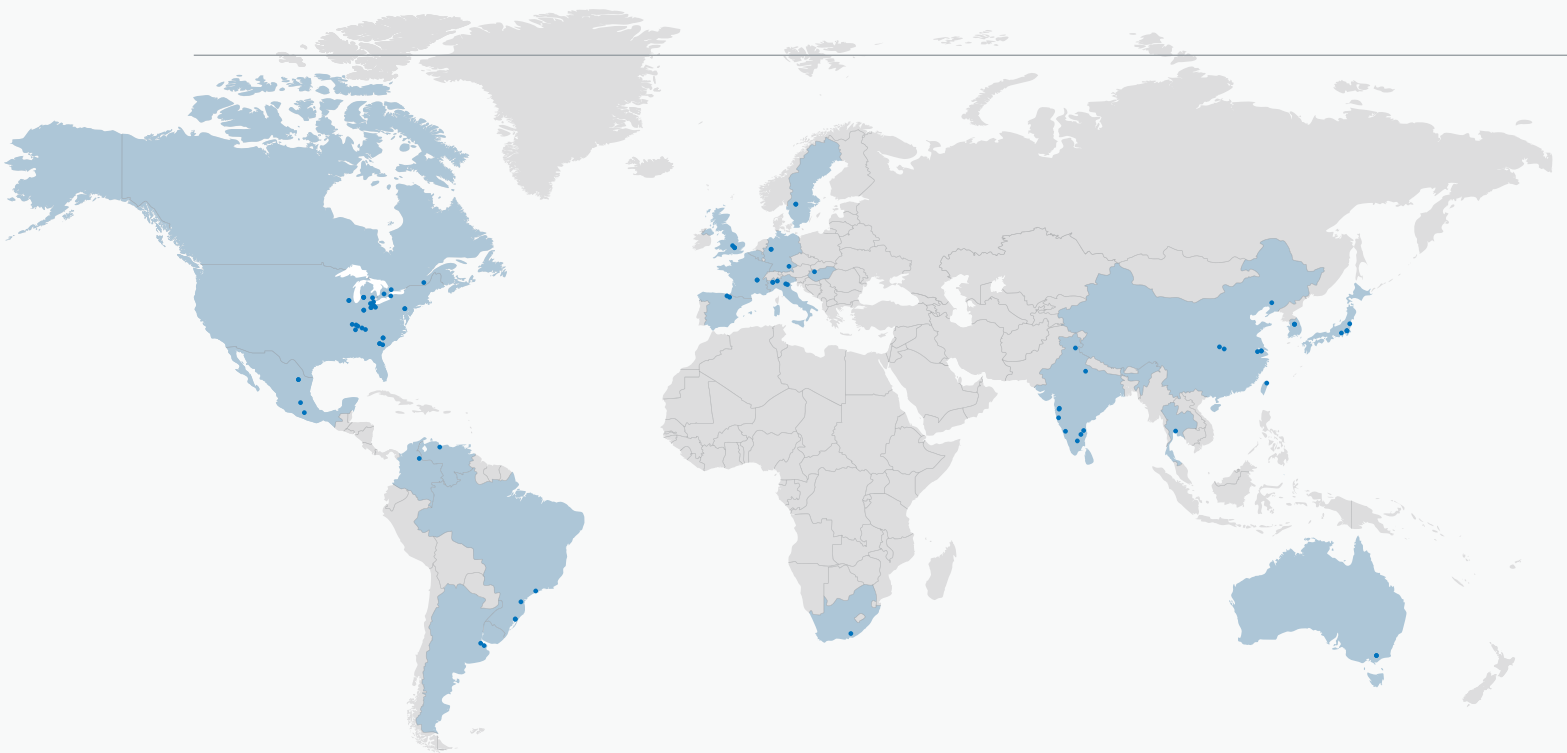

Arco, Italy



Brugge, Belgium



Gravatai, Brazil



Wuxi, China





SPICER®

Drivetrain Products

Axles

Driveshafts

Off-Highway Transmissions

VICTOR REINZ®

Sealing Products

Gaskets and Seals

Cylinder-Head Cover Modules

Thermal-Acoustic Protective Shielding

LONG®

Thermal Products

Transmission Oil Coolers

Engine Oil Coolers



About Dana Holding Corporation

Dana is an integral partner for virtually every major vehicle and engine manufacturer worldwide. Dana is a leading supplier of drivetrain, sealing, and thermal technologies to the global automotive, commercial-vehicle, and off-highway markets. Founded in 1904, the company employs thousands of people across five continents.

About the Dana Off-Highway Products Group

The Dana Off-Highway Products Group includes research and development, manufacturing, and assembly operations in Belgium, Brazil, China, Hungary, India, Italy, Mexico, the United Kingdom, and the United States. It designs, manufactures, assembles, and markets Spicer® axles and transaxles, driveshafts and end-fittings, transmissions, torque converters, electronic controls, and brakes. The group also provides genuine replacement parts and service.

The Dana Off-Highway Products Group serves more than 1,000 vehicle assembly and manufacturing facilities in 30 countries. It also has two global distribution centers and more than 50 authorized service centers supporting customers in more than 100 countries. Construction, agriculture, forestry, underground mining, material handling, outdoor power, leisure/utility vehicles, and industrial equipment are just some of the markets that demand the quality found in Spicer products and genuine service parts.



M. Knöpfli AG

Wiesackerstr. 128

8105 Regensdorf

Tel: ++41 44 840 62 21

info@m-knoepfli.com